

**Data Sheet**

**Model No.: SP-MBP278UYS**

**View angle:110**

Official Product	Part No. SP-MBP278UYS	Your Part No.		Data Sheet No.
Tentative Product	*****	*****		HDS-278-SP131
Specifications are subject to changes for improvement without advance notice. Proprietary data, drawings, and company confidential all rights reserved.		2005/9/7	Version of 1.0	Page 1/15

**INTRODUCTION ..... 3**

**PRODUCT SPECIFICATION..... 4**

    ATTENTION: ELECTRIC STATIC DISCHARGE (ESD) PROTECTION ..... 4

**DESCRIPTION OF MODEL NO. AND LOT NO. .... 5**

    MODEL NO. .... 5

    LOT No. .... 5

    PRODUCT FEATURE..... 6

    APPLICATION ..... 6

    PRODUCT OUT LINE DIMENSION (SP-MBP278UYS) ..... 7

**ELECTRO-OPTICAL..... 7**

    ABSOLUTE MAXIMUM RATINGS ..... 7

    ELECTRO-OPTICAL CHARACTERISTICS..... 8

    LUMINOUS FLUX RANK ..... 8

    ELECTRICAL RANK ..... 8

    DOMINANT WAVELENGTH RANK ..... 8

    CHARACTERISTICS (GENERAL)..... 9

    LEDs AND EYE SAFETY:..... 10

**TUBE AND PACKING ..... 11**

    TUBE DIMENSION ..... 11

    PACKING MODEL..... 12

**PRECAUTION OF APPLICATION ..... 12**

    DESIGNING 1: ..... 12

    DESIGNING 2: CIRCUIT LAYOUT ..... 13

    DESIGNING 3: MAX RATING..... 13

    STORAGE ..... 13

    SOLDERING ..... 13

    CLEANING ..... 13

**RELIABILITY TEST ..... 14**

**REVISE NOTES ..... 15**

Official Product	Part No. SP-MBP278UYS	Your Part No.		Data Sheet No.
Tentative Product	*****	*****		HDS-278-SP131
Specifications are subject to changes for improvement without advance notice. Proprietary data, drawings, and company confidential all rights reserved.		2005/9/7	Version of 1.0	Page 2/15

## Introduction

- The information contained herein is presented only as a guide for the applications of our products. No responsibility is assumed by SP for any infringements of intellectual property or other rights of the third parties which may result from its use.
- SP is continually making an effort to improve the quality of its products. Nevertheless, semiconductor devices in general can malfunction or fail due to their inherent electrical sensitivity and vulnerability to physical stress. It is the responsibility of the buyer, when utilizing SP products, to comply with the standards of safety in making a safe design for the entire system, and to avoid situations in which a malfunction or failure of such SP products cause loss of human life, bodily injury or damage to property.
- The SP products listed in this document are intended for usage in general electronics (computer, personal equipment, office equipment, industrial robotics, domestic, etc...) These products are neither intended nor warranted for usage in equipment that requires extraordinarily high quality and/or reliability or a malfunction or failure of which may cause loss of human life or bodily injury.
- In developing your designs, please ensure that SP products are used within specified operating ranges as set forth in the most recent SP products specifications.
- Also, please keep in mind of the precautions listed in this document.

Official Product	Part No. SP-MBP278UYS	Your Part No.		Data Sheet No.
Tentative Product	*****	*****		HDS-278-SP131
Specifications are subject to changes for improvement without advance notice. Proprietary data, drawings, and company confidential all rights reserved.		2005/9/7	Version of 1.0	Page 3/15

**Product Specification**

	Specification	Material	Quantity
Total Flux	Typ. 30lm @600mA/ Ta= 25°C		
Lambda	585nm-600nm @600mA/ Ta= 25°C		
V <sub>F</sub>	2.07V-2.79V @600mA/ Ta=25°C		
I <sub>R</sub>	SP standard		
Resin	White	Epoxy resin	
Tube	SP standard	Conductive	50pcs per tube
Label	SP standard	Paper	
Carton	SP standard	Paper	Non-specified

Others:

**ATTENTION: Electric Static Discharge (ESD) protection**



The symbol shown on the page herein to introduce 'Electro-Optical Characteristics'. ESD protection for GaP and AlGaAs based chips is still necessary even though they are safe in low static-electric discharge. Parts built with AlInGaP, GaN, or/and InGaN based chips are STATIC SENSITIVE devices. ESD protection has to be considered and taken in the initial design stage. If manual work/process is needed, please ensure the device is well protected from ESD during all the process.

Official Product	Part No. SP-MBP278UYS	Your Part No.		Data Sheet No.
Tentative Product	*****	*****		HDS-278-SP131
Specifications are subject to changes for improvement without advance notice. Proprietary data, drawings, and company confidential all rights reserved.		2005/9/7	Version of 1.0	Page 4/15

**Description of Model No. and Lot No.**

**Model No.**

**S P - M B P 2 7 8 U Y S**



Company	Product Name	Dice	Package	Emitter Color	Current code
SP: For Soft Power	MB: Metal Board P: Power Package	1: Single 2: Twin . .	Outline dimension	UY: Yellow	S:600mA

**Lot No.**

1 2 3 4 5 6 7 8 9 10  
**P 1 2 2 3 0 A - D T**

Code 1	Code 2	Code 3	Code 4, 5	Code 6, 7	Code 9	Code 10
	Mfg. Year	Mfg. Month	Mfg. Date	Lots	Resin Color	Packaging

Official Product	Part No. SP-MBP278UYS	Your Part No.		Data Sheet No.
Tentative Product	*****	*****		HDS-278-SP131
Specifications are subject to changes for improvement without advance notice. Proprietary data, drawings, and company confidential all rights reserved.		2005/9/7	Version of 1.0	Page 5/15

Internal Tracing Code	Z: 2000	1: Jan.	1~31/ (30)	01~99, A,B,C...	D: Milky White	T: Taped Reel
	1: 2001	2: Feb.				
	.....	A: Oct.				
		B: Nov.				
		C: Dec.				

**Product Feature**

- Wide view angle
- Easy to fixed
- No UV
- Long operating time (Up to 50,000hrs)
- Lower forward voltage operated
- More energy efficient than incandescent and most halogen lamps
- ESD: InGaN/Al<sub>2</sub>O<sub>3</sub> with 8KV
- Instant light (less than 100nS)

**Application**

- Reading lights (car, bus, aircraft)
- Portable (flashlight, bicycle)
- Task lighting
- Garden lighting
- Rail lighting
- Wayside lighting
- LCD Backlights
- Light Guides
- Traffic signaling
- Architectural lighting

Official Product	Part No. SP-MBP278UYS	Your Part No.		Data Sheet No.
Tentative Product	*****	*****		HDS-278-SP131
Specifications are subject to changes for improvement without advance notice. Proprietary data, drawings, and company confidential all rights reserved.		2005/9/7	Version of 1.0	Page 6/15

Product Out Line Dimension (SP-MBP278UYS)

Tolerance: +/-0.1

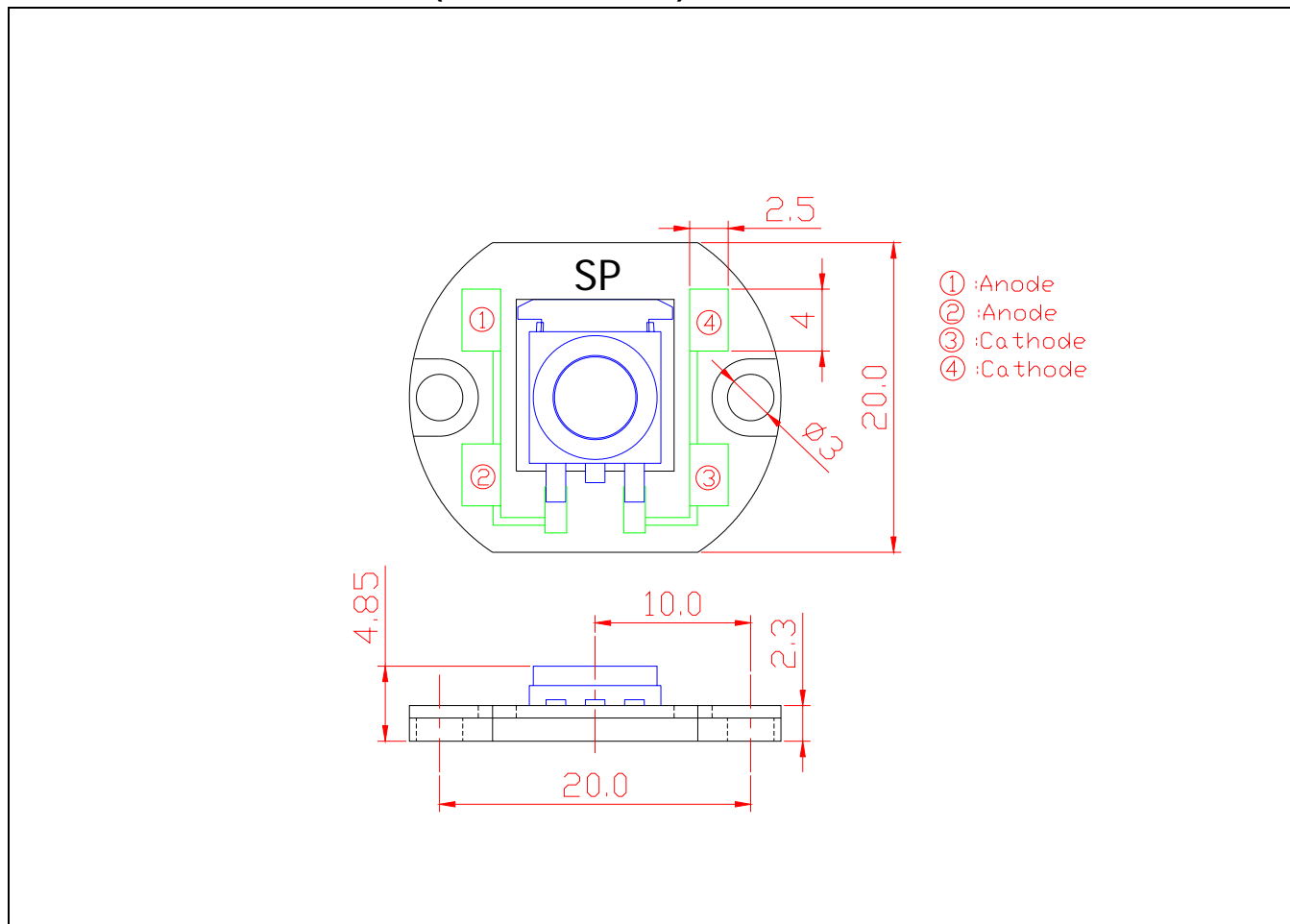

Electro-Optical

Absolute Maximum Ratings

(T<sub>a</sub> =25°C)

Parameter	Rating	Unit	Conditions
DC Forward Current* <sup>1</sup>	700	mA	-
Peak Pulsed Forward Current * <sup>2</sup>	800	mA	-
Reverse Voltage	5	V	-
LED junction Temperature	120	°C	-
Operating Temperature	-30~+85	°C	-
Storage Temperature	-40~+120	°C	-
Soldering Temperature	260	°C	For 5 sec. Max.

\*1: Proper current derating must be observed to maintain junction temperature below the maximum

\*2:tp ≤ 10μs, Duty cycle=0.01

Official Product	Part No. SP-MBP278UYS	Your Part No.		Data Sheet No.
Tentative Product	*****	*****		HDS-278-SP131
Specifications are subject to changes for improvement without advance notice. Proprietary data, drawings, and company confidential all rights reserved.		2005/9/7	Version of 1.0	Page 7/15

**Electro-Optical Characteristics**

 (T<sub>a</sub> =25°C)

Parameter	Symbol	Min.	TYP.	Max.	Unit
Viewing angle	2θ ½	-	110	-	Deg.
Forward Voltage (I <sub>F</sub> =600mA)	V <sub>F</sub>	2.07	-	2.79	V
Luminous Flux	Flux	18.1	30	-	lm
Dominant Wavelength	λ <sub>d</sub>	585	-	600	nm
Temperature Coefficient of Forward Voltage	ΔV <sub>F</sub> /ΔT	-	-2	-	mV/°C
Thermal Resistance Junction to Board (I <sub>F</sub> =600mA)	Rθ <sub>J-B</sub>	-	22	-	°C/W

**Luminous Flux Rank**

Rank Code	Symbol	Condition	Min.	Typ.	Max.	Unit
Full	ΦV	I <sub>F</sub> =600mA	18.1	-	51.7	lm
PN			18.1	-	23.5	
PP			23.5	-	30.6	
PQ			30.6	-	39.8	
PR			39.8	-	51.7	

Note: It maintains a tolerance of ±10% on flux

**Electrical Rank**

Rank Code	Symbol	Condition	Min.	Typ.	Max.	Unit
Full	V <sub>F</sub>	I <sub>F</sub> =600mA	2.07	-	2.79	V
P01			2.07	-	2.31	
P02			2.31	-	2.55	
P03			2.55	-	2.79	

Note: It maintains a tolerance of ±0.1V on forward voltage measurements

**Dominant Wavelength Rank**

Rank Code	Symbol	Condition	Min.	Typ.	Max.	Unit
Full	λ <sub>d</sub>	I <sub>F</sub> =600mA	584.5	-	597.0	nm
1			584.5	-	587.0	
2			587.0	-	589.5	
3			589.5	-	592.0	

Official Product	Part No. SP-MBP278UYS	Your Part No.		Data Sheet No.
Tentative Product	*****	*****		HDS-278-SP131
Specifications are subject to changes for improvement without advance notice. Proprietary data, drawings, and company confidential all rights reserved.		2005/9/7	Version of 1.0	Page 8/15



4			592.0	-	594.5	
5			594.5	-	597.0	

Note: It maintains a tolerance of  $\pm 0.5\text{nm}$  on dominant wavelength

**Characteristics (General)**

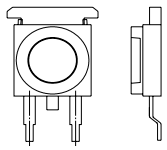

Horizontal

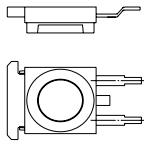

Vertical

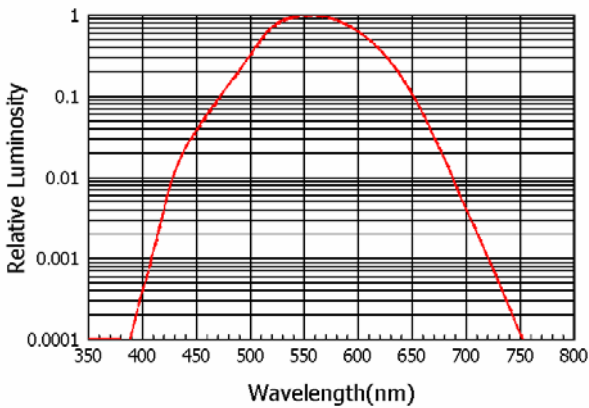
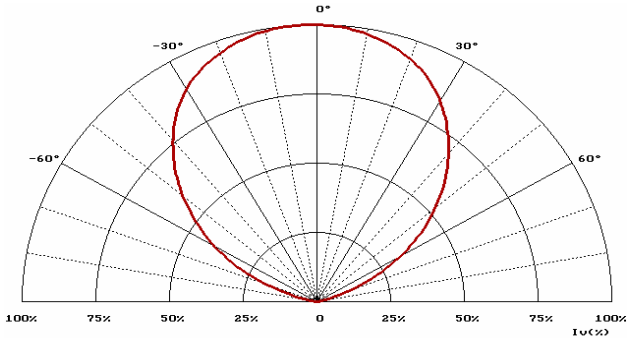
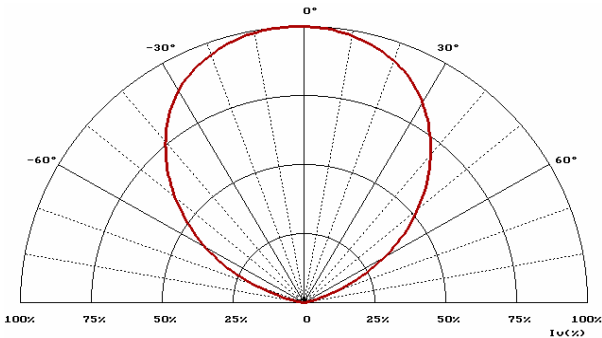

**Characteristics**

Official Product	Part No. SP-MBP278UYS	Your Part No.		Data Sheet No.
Tentative Product	*****	*****		HDS-278-SP131
Specifications are subject to changes for improvement without advance notice. Proprietary data, drawings, and company confidential all rights reserved.		2005/9/7	Version of 1.0	Page 9/15

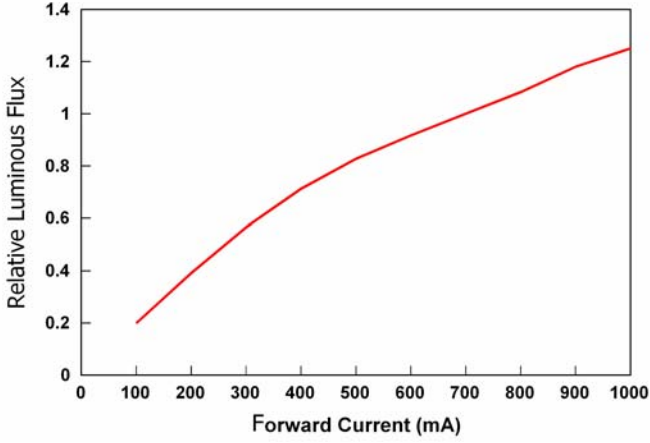
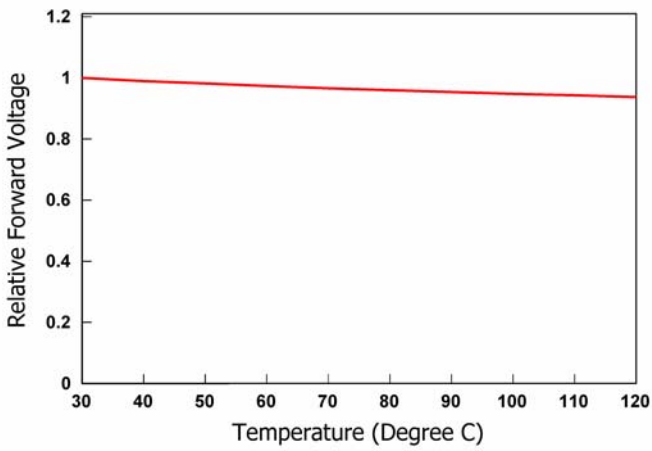
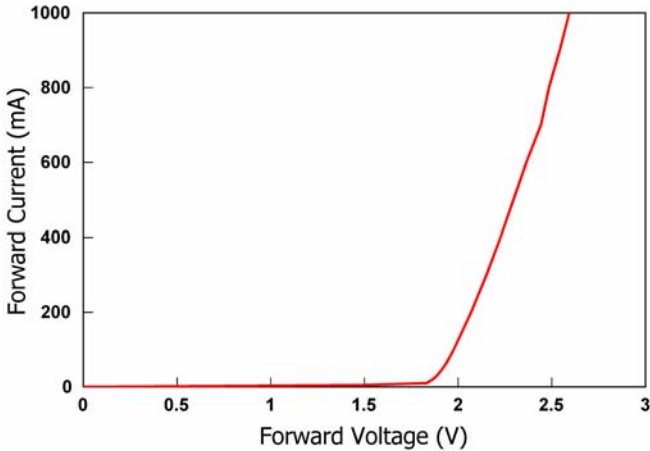
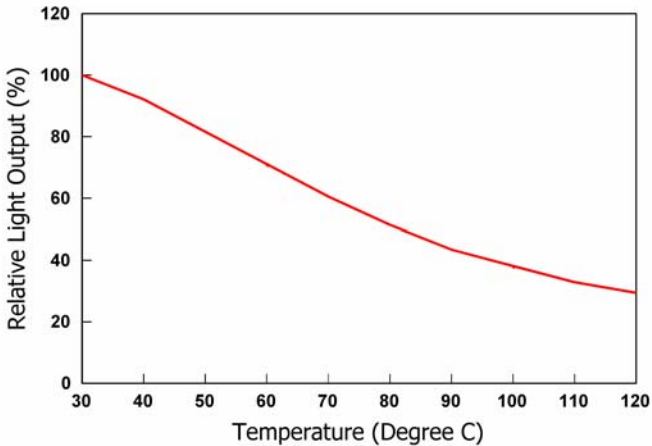
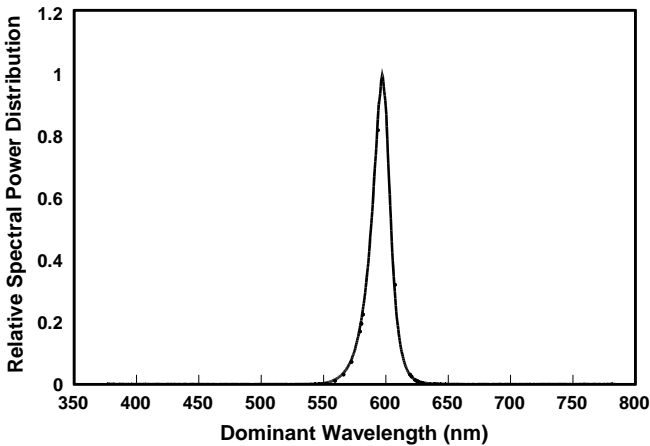

**LEDs and Eye Safety:**

In the 1993 edition of IEC-60825-1, LEDs were included: "Throughout this part 1 light emitting diodes (LED) are included whenever the word "laser" is used." The CENELEC document EN 60825-1 contains all the technical content of the IEC standard.

Official Product	Part No. SP-MBP278UYS	Your Part No.		Data Sheet No.
Tentative Product	*****	*****		HDS-278-SP131
Specifications are subject to changes for improvement without advance notice. Proprietary data, drawings, and company confidential all rights reserved.		2005/9/7	Version of 1.0	Page 10/15

The scope of the IEC standard states that "...products which are sold to other manufacturers for use as components of any system for subsequent sale are not subject to IEC 60825-1, since the final product will itself be subject to this standard." Therefore, it is important to determine the Laser Safety Class of the final product. However, it is important that employees working with LEDs are trained to use them safely.

Most of the products containing LEDs will fall in either Class 1 or Class 2. A Class 1 label is optional:

### CLASS 1 LED PRODUCT

If a label is not used, this description must be included in the information for the user. Amendment 2 to IEC 60825-1 is expected to be published in January 2001. The CENELEC equivalent is expected to follow three months after the IEC publication. This document contains increased Class 1 and Class 2 limits, as well as the introduction of less restrictive Class 1M and Class 2M.

For the exact classification and further information, the IEC document can be used:

EC-60825-1 ISBN 2-8318-4169-0

### Tube and Packing

#### Tube Dimension

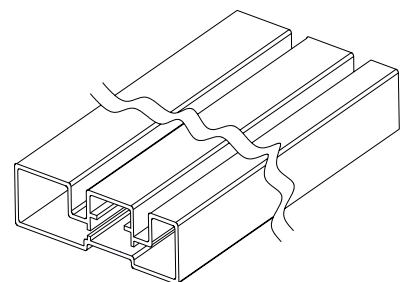
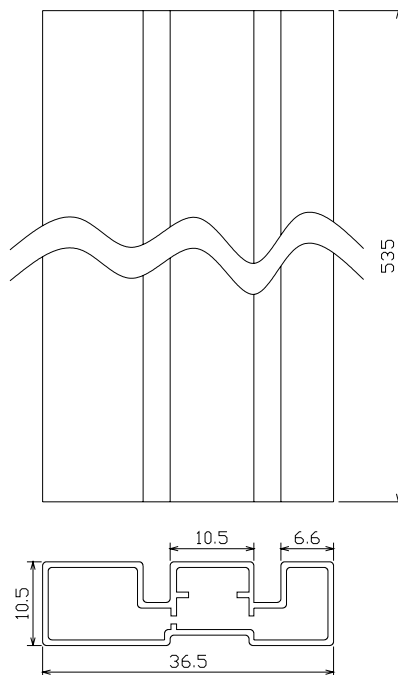

Official Product	Part No. SP-MBP278UYS	Your Part No.		Data Sheet No.
Tentative Product	*****	*****		HDS-278-SP131
Specifications are subject to changes for improvement without advance notice. Proprietary data, drawings, and company confidential all rights reserved.		2005/9/7	Version of 1.0	Page 11/15

**Packing Model**

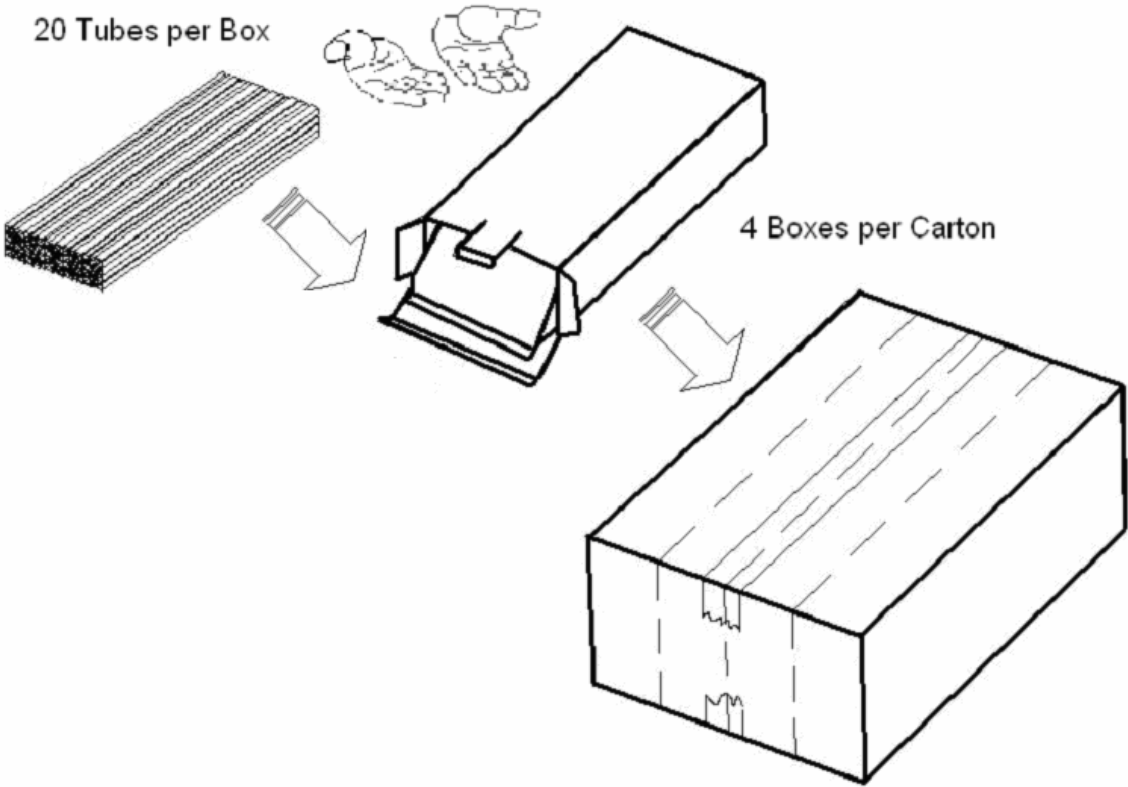

**Precaution of Application**

**Designing 1: Soldering Pattern**

The dimensions of the recommended soldering pattern may not meet every user. Please confirm and study first before designing the soldering pattern in order to obtain the best performance of soldering. Recommended soldering pattern is listed below:

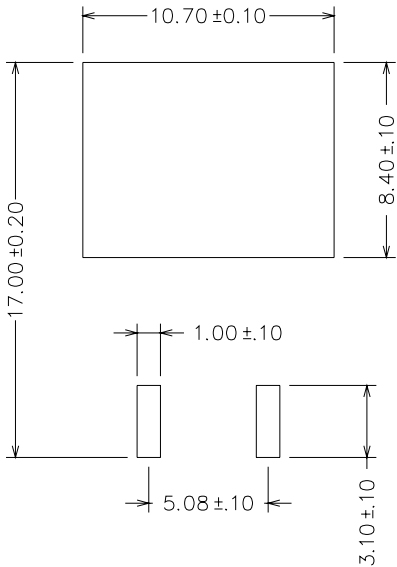

Official Product	Part No. SP-MBP278UYS	Your Part No.		Data Sheet No.
Tentative Product	*****	*****		HDS-278-SP131
Specifications are subject to changes for improvement without advance notice. Proprietary data, drawings, and company confidential all rights reserved.		2005/9/7	Version of 1.0	Page 12/15

**Designing 2: Circuit Layout**

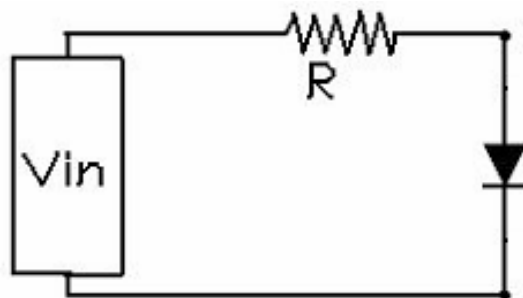

**Designing 3: Max Rating**

Any application should refer to the specifications of absolute maximum ratings.

**Storage**

It's recommended to store the products in the following conditions:

Humidity: 60 %RH Max.

Temperature: 5°C ~30°C (41°F~86°F)

**Soldering**

Manual soldering

Soldering tin material: tin 6/4 alloy or contained Ag.

To prevent cracking, please bake before manual soldering.

Temperature at tip of iron : 300°C±5°C Max.(25W)

It's banned to load any stress on the resin during soldering.

Soldering time : 3±1sec

**Cleaning**

The conditions of cleaning after soldering:

An alcohol-based solvent such as isopropyl alcohol (IPA) is recommended.

Temperature Time: <50°Cx30sec, or <30°Cx3min

Ultra sonic cleaning: < 15W/ bath; Bath volume: 1liter max.

Curing: 100°C max, <3min

Official Product	Part No. SP-MBP278UYS	Your Part No.		Data Sheet No.
Tentative Product	*****	*****		HDS-278-SP131
Specifications are subject to changes for improvement without advance notice. Proprietary data, drawings, and company confidential all rights reserved.		2005/9/7	Version of 1.0	Page 13/15

## Reliability Test

Item	Duration	Standards Reference		Conditions	Criteria
		MIL-STD 883 Ref	JIS C 7021 Ref		
High Temperature Operating Life (HTOL)	1000 Hours			55°C, I <sub>F</sub> =max DC (Note 1)	Note 2
Room Temperature Operating Life (RTOL)	1000 Hours			25°C, I <sub>F</sub> =max DC (Note 1)	Note 2
Low Temperature Operating Life (LTOL)	1000 Hours			-40°C, I <sub>F</sub> =max DC	Note 2
Wet High Temperature Operating Life (WHTOL)	1000 Hours		Method B-11, Condition C	85°C/85%RH, I <sub>F</sub> =max DC	Note 2
Powered Temperature Cycle (PTMCL)	200 Cycles			-40°C/85°C, 18min dwell, 42min xfer (2 hours cycle), 5min ON/ 5min OFF, I <sub>F</sub> =max DC	Note 2
Non Operating Temperature Cycle (TMCL)	200 Cycles	1010	Method A-4	-40°C/120°C, 30min dwell/ 5 min xfer	No Catastrophic
High Temperature Storage Life (HTSL)	1000 Hours	1005	Method B-10	110°C, non operating	Note 2
Low Temperature Storage Life (LTSL)	1000 Hours	1005	Method B-12	-40°C, non operating	Note 2
Non Operating Thermal Shock (TMSK)	200 Cycles			-40°C/110°C, 20min dwell/<20 sec xfer	No Catastrophic
Non Operating Thermal Shock (TMSK)	200 Cycles			-40°C/120°C, 20min dwell/<20 sec xfer	No Catastrophic
Mechanical Shock	5 Shocks	2002	Method A-7 Condition F	1500G, 0.5 sec pulse, 5shocks each 6 axis	No Catastrophic
Natural Drop	3X		Method A-8	On concrete from 1.2m	No Catastrophic
Variable Vibration Frequency		2007	Method A-10 Condition D	10-2000-10 Hz, log or linear sweep rate 20G about 1min, 1.5mm, 3X/axis	No Catastrophic
Variable Vibration Frequency		2007	Method A-10 Condition D	10-55-10 Hz, ± 0.75mm, 55-2000, 10G, 1 octave/min, 3X/axis	No Catastrophic
Random Vibration				6G RMS from 10 to 2KHz, 10min/axis	No Catastrophic
Solder Heat Resistance (SHR)				260°C±5°C, 10 sec	No Catastrophic
Solder ability				Steam age for 16hr, then solder dip at 245 °C for 5sec	Solder Coverage
Lead Strength				1 lb, 30sec	No Catastrophic
Lead Fatigue				1 lb, 3X45° bend	No Catastrophic
Salt AtmoHThere	48 Hours	1009		35°C	No Catastrophic

Note 1: Depending on the maximum de-rating curve

Note 2: Failure criteria includes units with catastrophic failure, or units with greater than 50% I<sub>v</sub> degradation at 1000 hours, or an average I<sub>v</sub> degradation for the test of greater than 35% at 1000 hours

Official Product	Part No. SP-MBP278UYS	Your Part No.		Data Sheet No.
Tentative Product	*****	*****		HDS-278-SP131
Specifications are subject to changes for improvement without advance notice. Proprietary data, drawings, and company confidential all rights reserved.		2005/9/7	Version of 1.0	Page 14/15

**Revise Notes**

Rev.	Descriptions	Date	Name
1.0	-	6/17/2005	Ricky_Wu
1.1	1. Modify the Absolute Maximum Rating(700mA changed to 800mA) and add the *1	9/5/2005	Ricky_Wu

Official Product	Part No. SP-MBP278UYS	Your Part No.		Data Sheet No.
Tentative Product	*****	*****		HDS-278-SP131
Specifications are subject to changes for improvement without advance notice. Proprietary data, drawings, and company confidential all rights reserved.		2005/9/7	Version of 1.0	Page 15/15