

**Harvatek Surface Mount CHIP LEDs Approval Sheet  
Model No.: HT-F118BP**

**Acknowledged by**

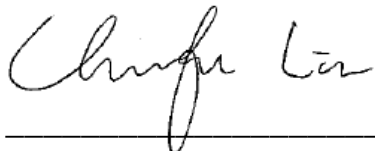

**Section Manager**  
**Production Engineering Dept.**

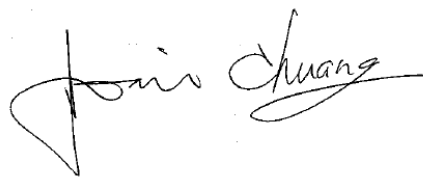

**Manager**  
**Production Engineering Dept.**

Official Product	HT Part No. HT-F118BP	Your Part No.		Data Sheet No.
Tentative Product	*****	*****		HDS-F118-K117
Specifications are subject to changes for improvement without advance notice. Proprietary data, drawings, and company confidential all rights reserved.		2004/11/17	Version of 2.0	Page 1/13

**INTRODUCTION** ..... 3

**PRODUCT SPECIFICATION** ..... 4

**ATTENTION: ELECTRICSTATIC DISCHARGE (ESD) PROTECTION** ..... 4

**LABEL SPEC.:** ..... 5

**PRODUCT FEATURE** ..... 7

**ELECTRO-OPTICAL CHARACTERISTICS** ..... 7

**PACKAGE OUTLINE DIMENSION AND RECOMMENDED SOLDERING PATTERN FOR REFLOW**

**SOLDERING** ..... 7

**ABSOLUTE MAXIMUM RATINGS** ..... 7

**CHARACTERISTICS OF HT-F118 SERIES** ..... 8

**PACKAGING TAPE, REEL, AND PACKING MODEL** ..... 9

**TAPE DIMENSION** ..... 9

**REEL DIMENSION** ..... 9

**PACKING MODEL**..... 10

**DRY PACK**..... 10

**CAUTIONS OF PICK AND PLACE** ..... 11

**PRECAUTIONS**..... 11

**SOLDERING PATTERN**..... 11

**REFLOW SOLDERING** ..... 12

**CLEANING** ..... 12

**CAUTIONS OF PICK AND PLACE** ..... 12

**RELIABILITY TEST** ..... 13

Official Product	HT Part No. HT-F118BP	Your Part No.		Data Sheet No.
Tentative Product	*****	*****		HDS-F118-K117
Specifications are subject to changes for improvement without advance notice. Proprietary data, drawings, and company confidential all rights reserved.		2004/11/17	Version of 2.0	Page 2/13

## Introduction

- *The information contained herein is presented only as a guide for the applications of our products. No responsibility is assumed by HARVATEK for any infringements of intellectual property or other rights of the third parties which may result from it use.*
- *Harvatek is continually effort to improve the quality of its products. Nevertheless, semiconductor devices in general can malfunction or fail due to their inherent electrical sensitivity and vulnerability to physical stress. It is the responsibility of the buyer, when utilizing HARVATEK products, to comply with the standards of safety in making a safe design for the entire system, and to avoid situations in which a malfunction or failure of such HARATEK products cause loss of human life, bodily injury or damage to property.*
- *The HARVATEK products listed in this document are intended for usage in general electronics (computer, personal equipment, office equipment, industrial robotics, domestic, etc...) These products are neither intended nor warranted for usage in equipment that requires extraordinarily high quality and/or reliability or a malfunction or failure of which may cause loss of human life or bodily injury.*
- *In developing your designs, please ensure that HARVATEK products are used within specified operating ranges as set forth in the most recent HARVATEK products specifications.*
- *Also, please keep in mind the precautions listed in this document.*

Official Product	HT Part No. HT-F118BP	Your Part No.		Data Sheet No.
Tentative Product	*****	*****		HDS-F118-K117
Specifications are subject to changes for improvement without advance notice. Proprietary data, drawings, and company confidential all rights reserved.		2004/11/17	Version of 2.0	Page 3/13

## Product Specification

	Specification	Material	Quantity
Iv	560-1000mcd @20mA/ Ta= 25° C Tolerance: ± 10%		
Chromaticity Coordinates	Refer to page 6 @20mA/ Ta= 25° C		
Vf	2.7~3.9v @20mA/ Ta= 25° C		
Ir	< 100 µA @ V <sub>R</sub> = 5 V		
Resin	Yellow	Epoxy resin	
Carrier tape	According to EIA 481-1A specs	Conductive black tape	2000pcs per reel
Reel	According to EIA 481-1A specs	Conductive black	
Label	HT standard	Paper	
Packing bag	220x240mm	Aluminum laminated bag/ no-zipper	One reel one bag
Carton	HT standard	Paper	Non-specified

Others:

Every mid-box will be loaded 5 reels. These 5 reels can be different in lot, Iv, lambda, or Vf. Every reel will have an independent label to identify its specification and the mid-box there will have a corresponding label post on it.

### ATTENTION: Electricstatic Discharge (ESD) protection



The symbol shown on the page herein to introduce 'Electro-Optical Characteristics'. ESD protection for GaP and AlGaAs based chips is still necessary even though they are safe in low static-electric discharge. Parts built with AlInGaP, GaN, or/and InGaN based chips are **STATIC SENSITIVE devices**. ESD protection has to be considered and taken in the initial design stage.

If manual work/process is needed, please ensure the device is well protected from ESD during all the process.

Official Product	HT Part No. HT-F118BP	Your Part No.		Data Sheet No.
Tentative Product	*****	*****		HDS-F118-K117
Specifications are subject to changes for improvement without advance notice. Proprietary data, drawings, and company confidential all rights reserved.		2004/11/17	Version of 2.0	Page 4/13

**Label Spec.:**

<b>HARVATEK</b>		Date: yyyy/mm/dd 
CUSTOMER P/N: 		
HARVATEK P/N: 	QTY: PCS 	
LOT NO: 	QC	
IV BIN:    COLOR BIN:    VF:		

■ **Customer P/N: To Be Defined**

■ **Harvatek P/N**

**H T - F 1 1 8 BP**



Series Name	Emitting Color
HT-F118: 3.2x1.2x0.8mm	BP: White@20mA

■ **Lot No.**

1    2    3    4    5    6    7    8    9    10  
**P 1 2 2 3 0 A - C T**

Code 1	Code 2	Code 3	Code 4, 5	Code 6, 7	Code 9	Code 10
	Mfg. Year	Mfg. Month	Mfg. Date	Lots	Resin Color	Packaging
Internal Tracing Code	Z: 2000 1: 2001 2: 2002 3: 2003 .....	1: Jan. 2: Feb. .... 9: Sep. A: Oct. B: Nov. C: Dec.	1~31/ (30)	01~99, A,B,C...	C: Water Clear	T: Taped Reel

Official Product	HT Part No. HT-F118BP	Your Part No.		Data Sheet No.
Tentative Product	*****	*****		HDS-F118-K117
Specifications are subject to changes for improvement without advance notice. Proprietary data, drawings, and company confidential all rights reserved.		2004/11/17	Version of 2.0	Page 5/13

■ Iv Bin:

Color	Bin Code	Spec. Range
White	W1	560-630mcd
	W2	560-715mcd
	X1	715-800mcd
	X2	800-900mcd
	Y1	900-1000mcd

■ Color Bin:

		Rank A0			
x	0.280	0.264	0.283	0.296	
y	0.248	0.267	0.305	0.276	
		Rank B3			
x	0.287	0.283	0.304	0.307	
y	0.295	0.305	0.330	0.315	
		Rank B4			
x	0.307	0.304	0.330	0.330	
y	0.315	0.330	0.360	0.339	

		Rank C0			
x	0.330	0.330	0.361	0.356	
y	0.318	0.360	0.385	0.351	
		Rank B5			
x	0.296	0.287	0.307	0.311	
y	0.276	0.295	0.315	0.294	
		Rank B6			
x	0.311	0.307	0.330	0.330	
y	0.294	0.315	0.339	0.318	

■ Vf Bin:

Color	Bin Code	Spec. Range
White	G8	2.7-2.9V
	H7	2.9-3.1V
	H8	3.1-3.3V
	J7	3.3-3.5V
	J8	3.5-3.7V
	K7	3.7-3.9V

Official Product	HT Part No. HT-F118BP	Your Part No.		Data Sheet No.
Tentative Product	*****	*****		HDS-F118-K117
Specifications are subject to changes for improvement without advance notice. Proprietary data, drawings, and company confidential all rights reserved.		2004/11/17	Version of 2.0	Page 6/13

## Product Feature

### Electro-Optical Characteristics

( $I_F @ 20\text{mA}$ ,  $T_a 25^\circ\text{C}$ )

Code for parts	Lighting Color	Material	$V_F(\text{V})$		$\lambda(\text{nm})$	$I_V(\text{mcd})$
			typ	max	$\lambda_D$	Min.
HT-F118BP	White	InGaN	3.3	3.9	X:0.29 Y:0.32	560

### Package Outline Dimension and Recommended Soldering Pattern for Reflow Soldering

Unit: mm Tolerance: +/-0.1

Outline Dim.

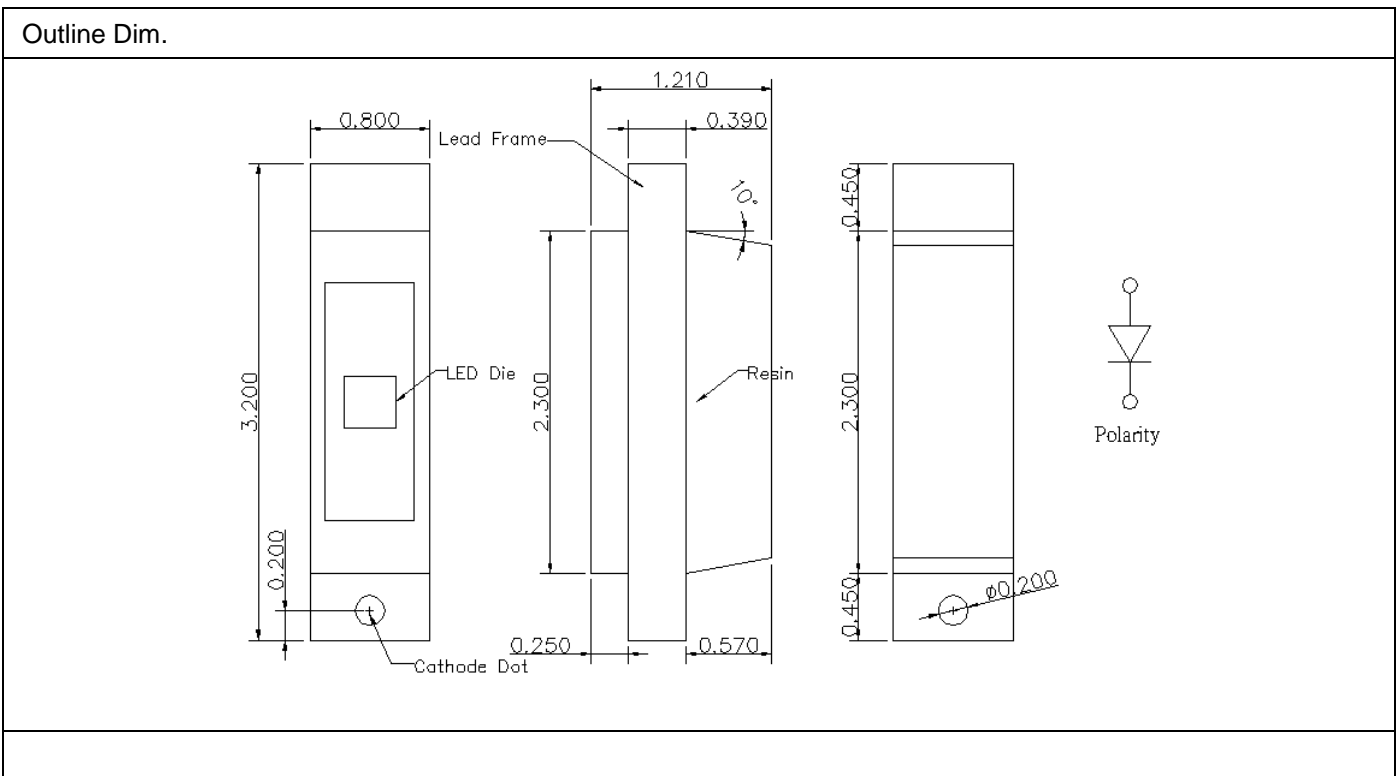

### Absolute Maximum Ratings

( $T_a 25^\circ\text{C}$ )

Series	$P_d(\text{mW})$	$I_F(\text{mA})$	$I_{FP}(\text{mA})$	$V_R(\text{V})$	$I_R(\mu\text{A})$	$T_{OP}(\text{C}^\circ)$	$T_{ST}(\text{C}^\circ)$
HT-F118BP	78	20	80**	5	<100@ $V_R = 5$	-30~+80	-40~+85

\*\* Condition for  $I_{FP}$  is pulse of 1/10 duty and 0.1msec width

Official Product	HT Part No. HT-F118BP	Your Part No.		Data Sheet No.
Tentative Product	*****	*****		HDS-F118-K117
Specifications are subject to changes for improvement without advance notice. Proprietary data, drawings, and company confidential all rights reserved.		2004/11/17	Version of 2.0	Page 7/13

## Characteristics of HT-F118 Series

Relative Intensity vs. Forward Current

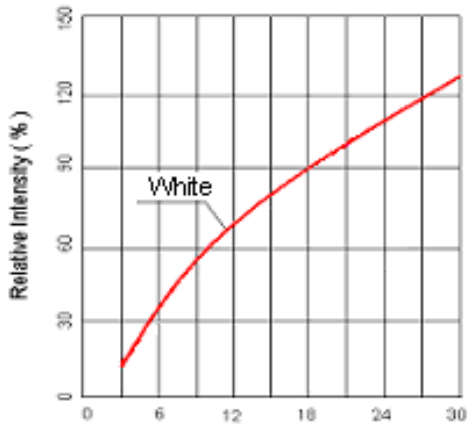

Forward Current vs. Ambient Temperature

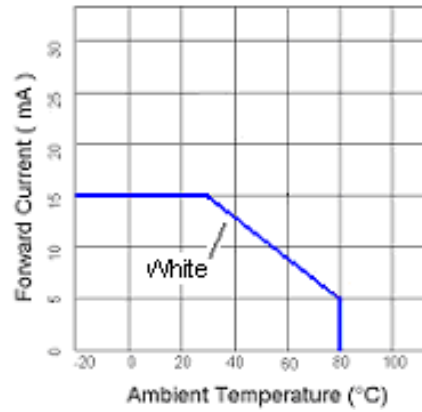

Forward Voltage vs. Forward Current

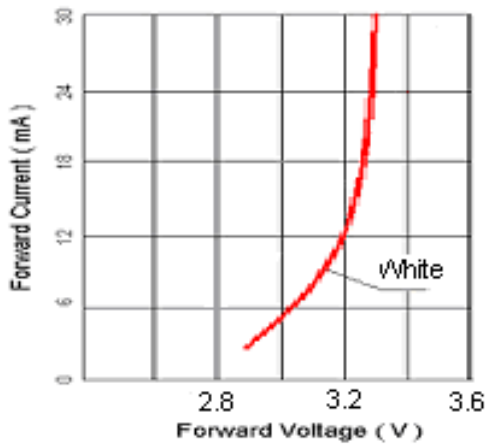

Directive Characteristics

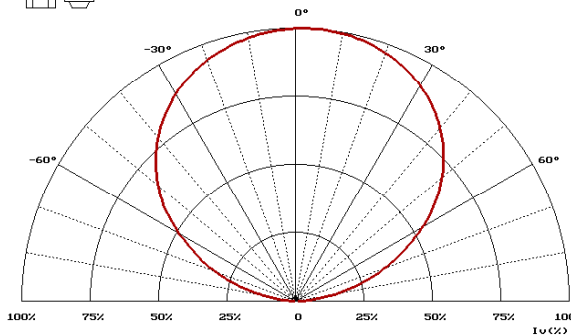

Directive Characteristics

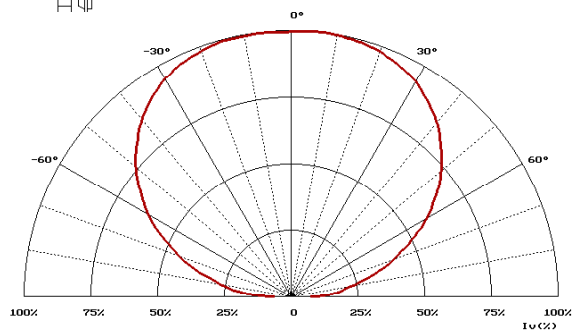

Official Product	HT Part No. HT-F118BP	Your Part No.	Data Sheet No.
Tentative Product	*****	*****	HDS-F118-K117
Specifications are subject to changes for improvement without advance notice. Proprietary data, drawings, and company confidential all rights reserved.		2004/11/17	Version of 2.0
			Page 8/13



## Packaging Tape, Reel, and Packing Model Tape Dimension

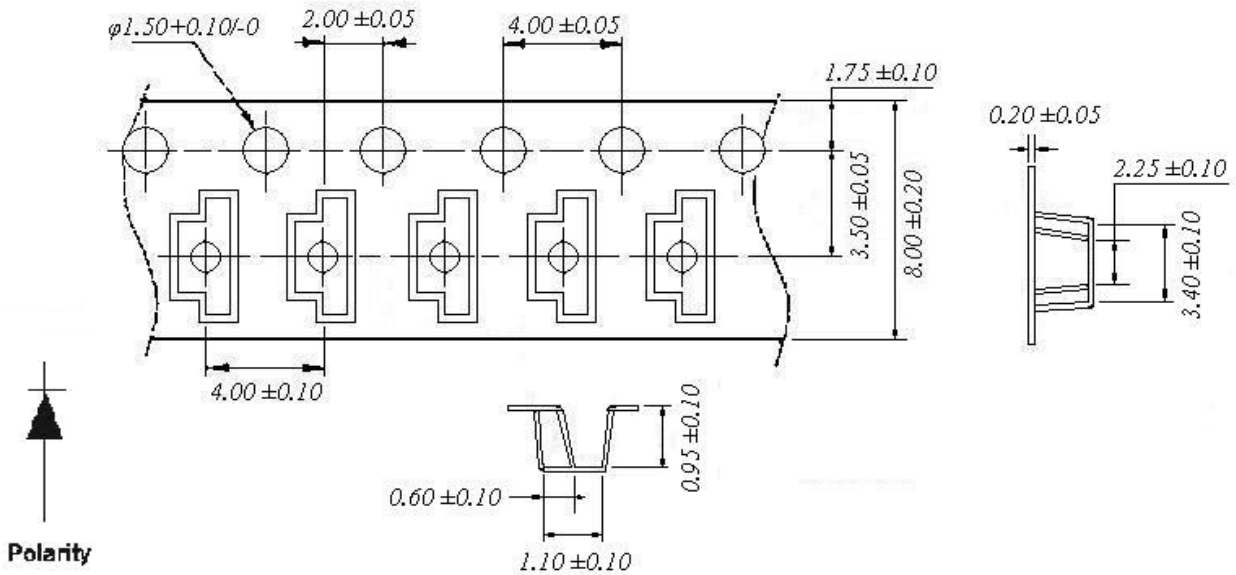

Unit: mm Tolerance: + / - 0.1 mm

## Reel Dimension

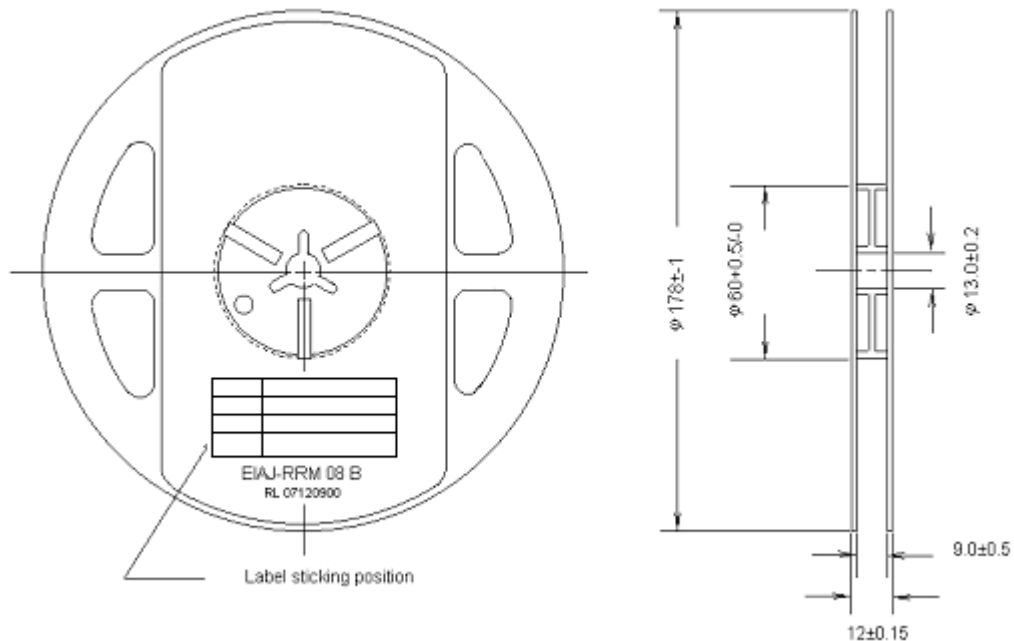

Official Product	HT Part No. HT-F118BP	Your Part No.		Data Sheet No.
Tentative Product	*****	*****		HDS-F118-K117
Specifications are subject to changes for improvement without advance notice. Proprietary data, drawings, and company confidential all rights reserved.		2004/11/17	Version of 2.0	Page 9/13

## Packing Model

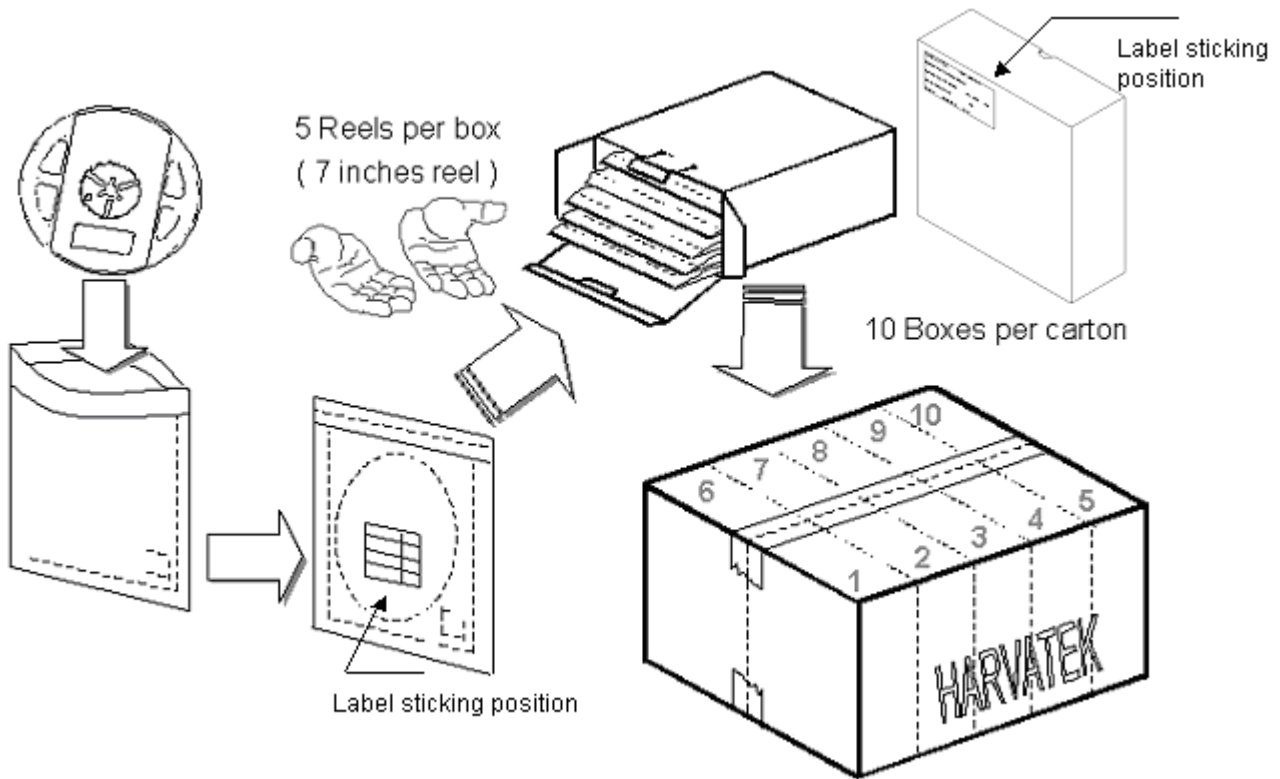

5 boxes per carton is available according to shipping quantity.

### Dry Pack

Any SMD optical device, like this chip LED, is **MOISTURE SENSITIVE device**. Avoid absorbing moisture at any time during transportation or storage. Every reel will be packaged in the moisture barrier anti-static bag (Specific bag material will depend upon customers' requirement or option). And the bag is well sealed before shipment.

By customer's requirement, we will put a humidity indicator in each moisture barrier anti-static bag before shipment.

The package is the following:

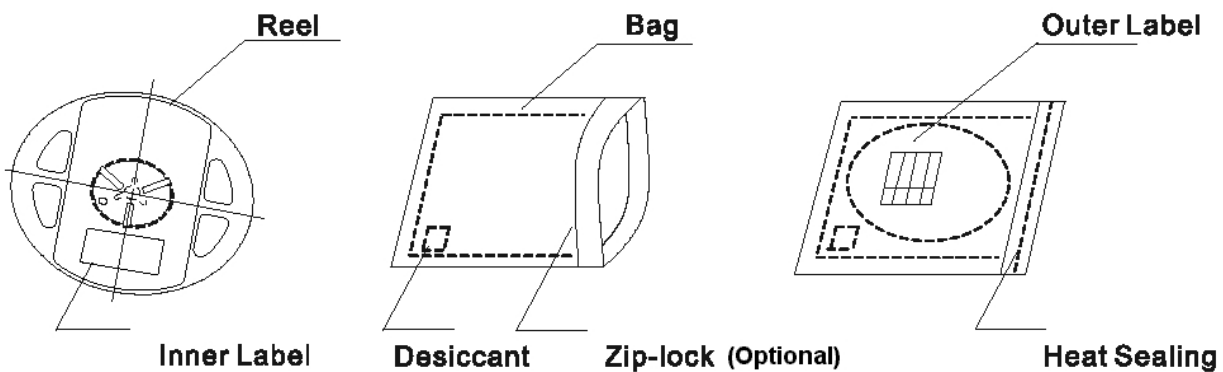

Official Product	HT Part No. HT-F118BP	Your Part No.	Data Sheet No.
Tentative Product	*****	*****	HDS-F118-K117
Specifications are subject to changes for improvement without advance notice. Proprietary data, drawings, and company confidential all rights reserved.		2004/11/17	Version of 2.0
			Page 10/13

### Cautions of Pick and Place

It should be avoided to load stress on the resin during high temperature.

Avoid rubbing or scraping the resin by any object.

Electric-static may cause damage to the component. Please confirm that the equipment grounding well. Using an ionizer fan is recommended.

### PRECAUTIONS

1. Avoid absorbing moisture at any time during transportation or storage.
2. Anti-Static process is needed especially when handling GaN, InGaN, and AlInGaP products.
3. It is suggested to connect the unit with a proper series current limit resistor. Avoid driving reverse voltage over the specification of LEDs when turning the unit ON/OFF.
4. Any application should refer to the specifications of absolute maximum ratings.
5. Avoid any direct contact with the viewing area.
6. If possible, assemble the unit in a clean room or dust-free environment.

### Soldering pattern

The dimensions of the recommended soldering pattern may not meet every user. Please confirm and study first before designing the soldering pattern in order to obtain the best performance of soldering. Recommended soldering pattern is listed below.

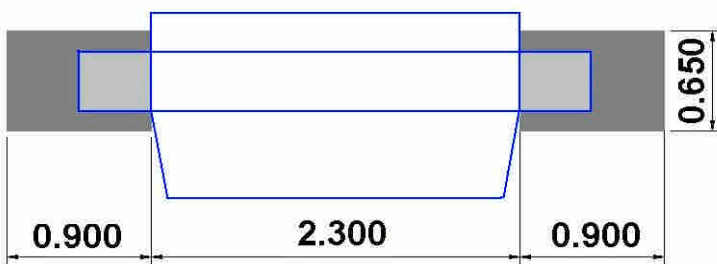

Soldering terminal may shift in x, y direction.

Official Product	HT Part No. HT-F118BP	Your Part No.		Data Sheet No.
Tentative Product	*****	*****		HDS-F118-K117
Specifications are subject to changes for improvement without advance notice. Proprietary data, drawings, and company confidential all rights reserved.		2004/11/17	Version of 2.0	Page 11/13

**Reflow Soldering**

Recommend soldering paste specifications:

Melting temperature: 178~192 °C

Contains: Sn 63%, Pb 37%

Never take next process until the component is cooled down to room temperature after reflow. The recommended reflow soldering profile (measuring on the surface of the LED terminal) is following:

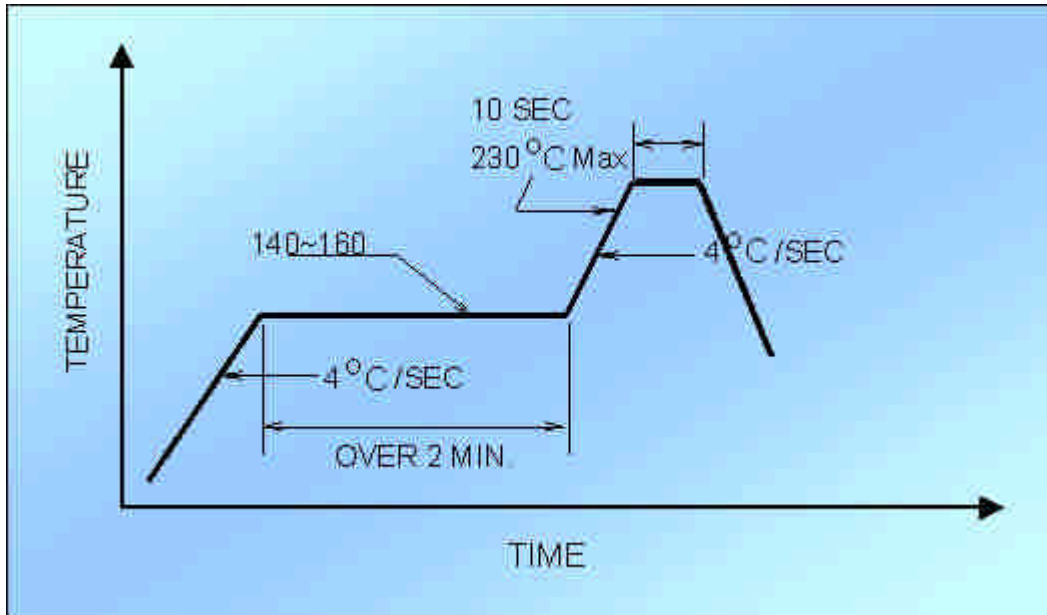

**Cleaning**

The conditions of cleaning after soldering:

An alcohol-based solvent such as isopropyl alcohol (IPA) is recommended.

Temperature x Time: <50 °C x 30sec, or <30 °C x 3min

Ultra sonic cleaning: < 15W/ bath; Bath volume: 1liter max.

Curing: 100 °C max, <3min

Do not contact with component on the assembly board.

**Cautions of Pick and Place**

It should be avoided to load stress on the resin during high temperature.

Avoid rubbing or scraping the resin by any object.

Electric-static may cause damage to the component. Please confirm that the equipment grounding well. Using an ionizer fan is recommended.

Official Product	HT Part No. HT-F118BP	Your Part No.		Data Sheet No.
Tentative Product	*****	*****		HDS-F118-K117
Specifications are subject to changes for improvement without advance notice. Proprietary data, drawings, and company confidential all rights reserved.		2004/11/17	Version of 2.0	Page 12/13

## Reliability Test

Item	Frequency/ lots/ samples/ failures	Standards Reference	Conditions
Precondition	For all reliability monitoring tests according to JEDEC Level 2	J-STD-020	1.) Baking at 85°C for 24hrs 2.) Moisture storage at 85°C/ 60% R.H. for 168hrs
Solderability	1Q/ 1/ 22/ 0	JESD22-B102-B And CNS-5068	Accelerated aging 155°C/ 24hrs Tinning speed: 2.5±0.5cm/s Tinning: A: 215°C/ 3±1s or B: 260°C/ 10±1s
Resistance to soldering heat		CNS-5067	Dipping soldering terminal only Soldering bath temperature A: 260±/-5°C; 10±/-1s B: 350±/-10°C; 3±/-0.5s
Operating life test	1Q/ 1/ 40/ 0	CNS-11829	1.) Precondition: 85°C baking for 24hrs 85°C/ 60%R.H. for 168hrs 2.) T <sub>amb</sub> 25°C; I <sub>F</sub> =20mA; duration 1000hrs
High humidity, high temperature bias	1Q/ 1/ 45/ 0	JESD-A101-B	T <sub>amb</sub> : 85°C Humidity: 85% R.H., I <sub>F</sub> =5mA Duration: 1000hrs
High temperature bias	1Q/ 1/ 20	HT specs.	T <sub>amb</sub> : 55°C I <sub>F</sub> =20mA Duration: 1000hrs
Pulse life test	1Q/ 1/ 40/ 0		T <sub>amb</sub> 25°C, I <sub>F</sub> =20mA,, I <sub>p</sub> =100mA, Duty cycle=0.125 (tp=125 μs, T=1sec) Duration 500hrs)
Temperature cycle	1Q/ 1/ 76/ 0	JESD-A104-A IEC 68-2-14, Nb	A cycle: -40 degree C 15min; +85 degree C 15min Thermal steady within 5 min.. 300 cycles 2 chamber/ Air-to-air type
High humidity storage test	1Q/ 1/ 40/ 0	CNS-6117	60±3°C 90+5/-10% R.H. for 500hrs
High temperature storage test	1Q/ 1/ 40/ 0	CNS-554	100±10°C for 500hrs
Low temperature storage test	1Q/ 1/ 40/ 0	CNS-6118	-40±5°C for 500hrs

Official Product	HT Part No. HT-F118BP	Your Part No.		Data Sheet No.
Tentative Product	*****	*****		HDS-F118-K117
Specifications are subject to changes for improvement without advance notice. Proprietary data, drawings, and company confidential all rights reserved.		2004/11/17	Version of 2.0	Page 13/13